

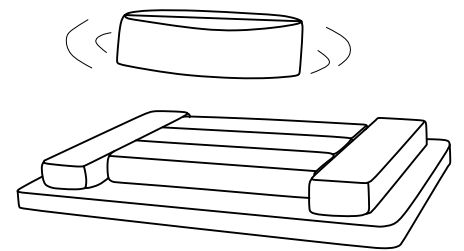

The  
Quantum  
Materials  
Colouring  
Book

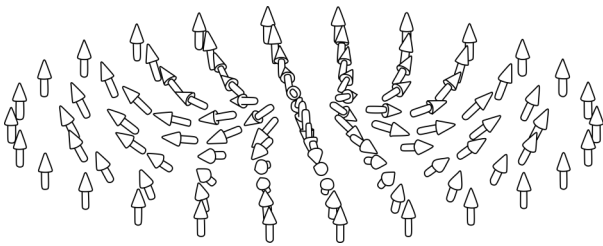

# Welcome to the World of Quantum Materials!



You are surrounded by quantum materials!

A quantum material is something with interesting properties that can only be explained using the theory of quantum mechanics.

Scientists study these materials and try to make new and better versions of them.

Join us as we take a trip through the world of quantum materials!

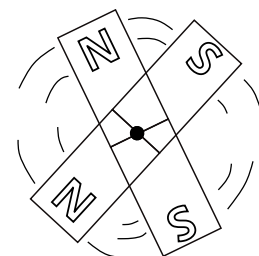
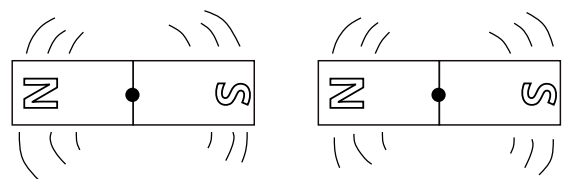
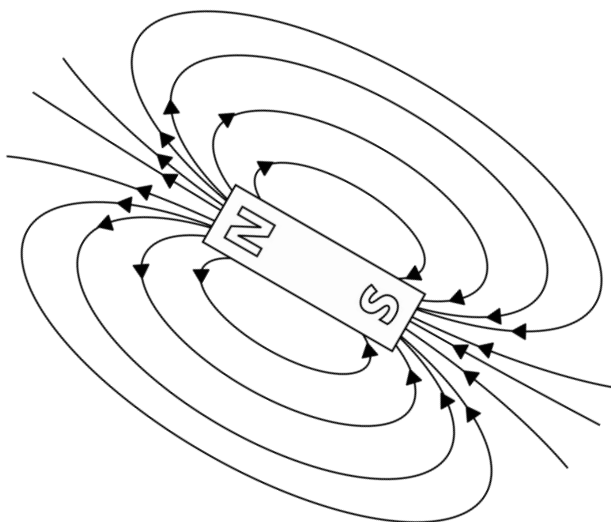
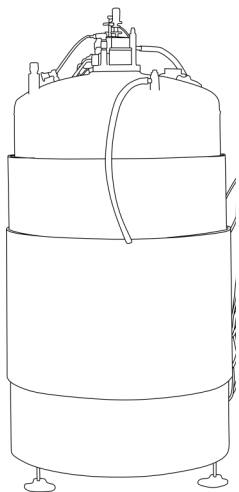
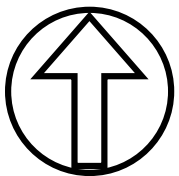
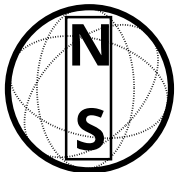
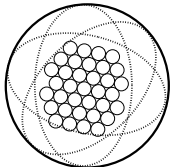
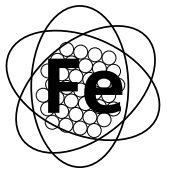

# Magnetism

Magnets can come in all sorts of shapes and sizes - horseshoes, bar magnets, cubes, cylinders, and even the Earth!

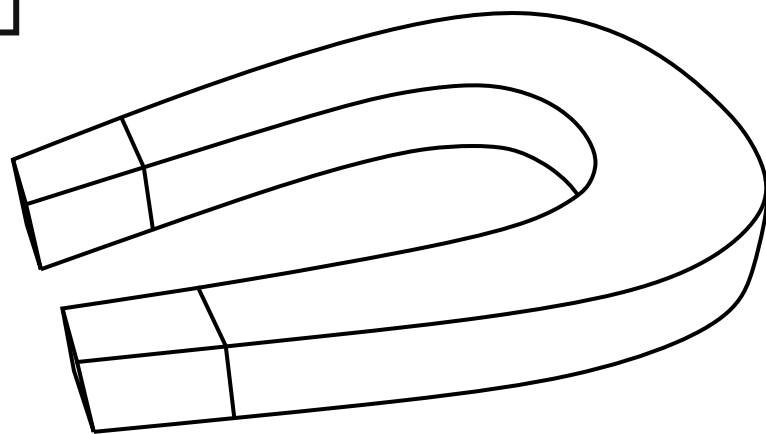

No matter what a magnet looks like, it will always have two poles - a North pole and a South pole.

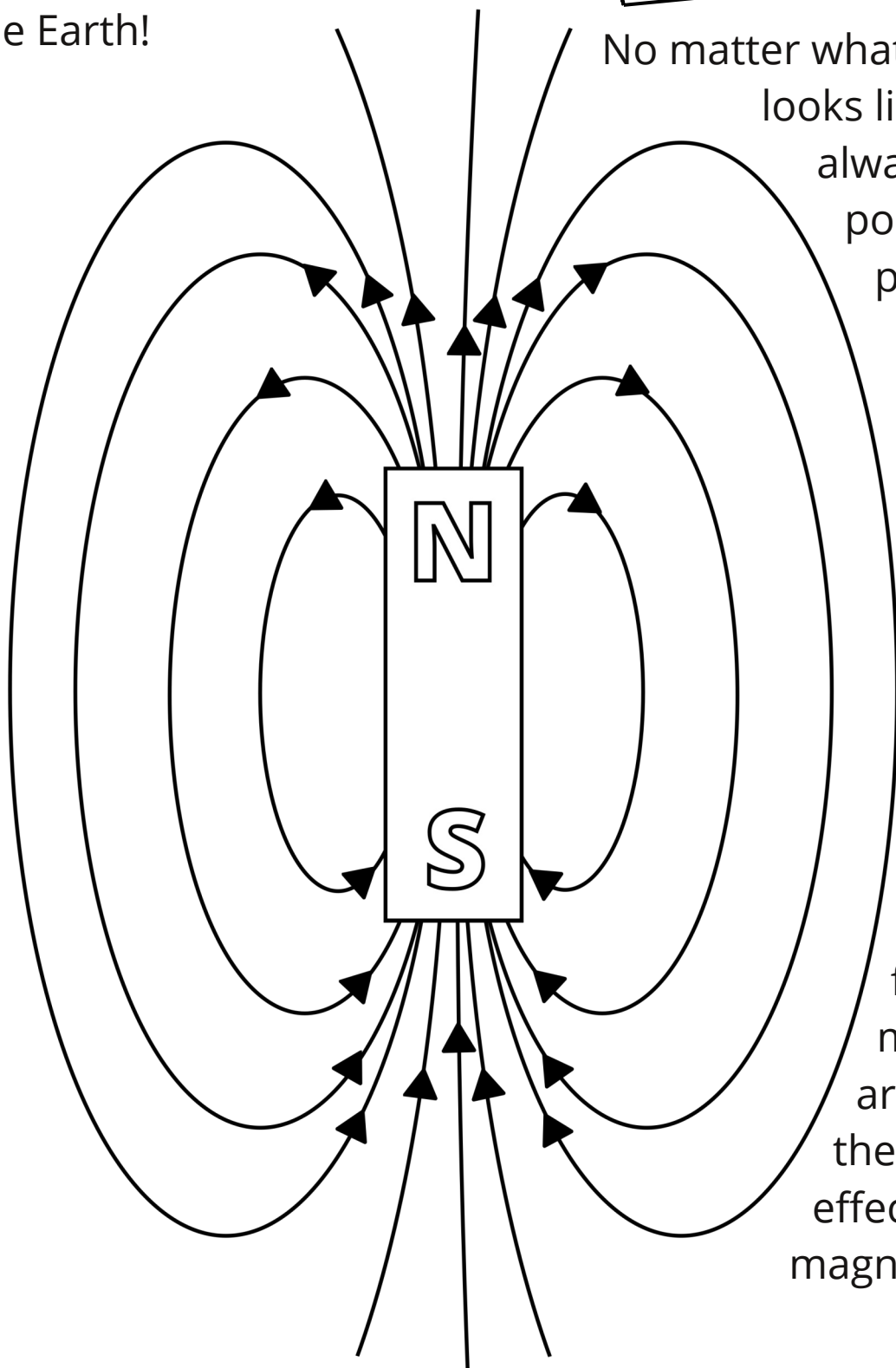

We draw lines to show the "magnetic field". The more lines are in an area, the stronger the effect of the magnet is there.

Magnets have been used by humans for thousands of years and can be dug out of the ground! These "natural" magnets are called lodestones.

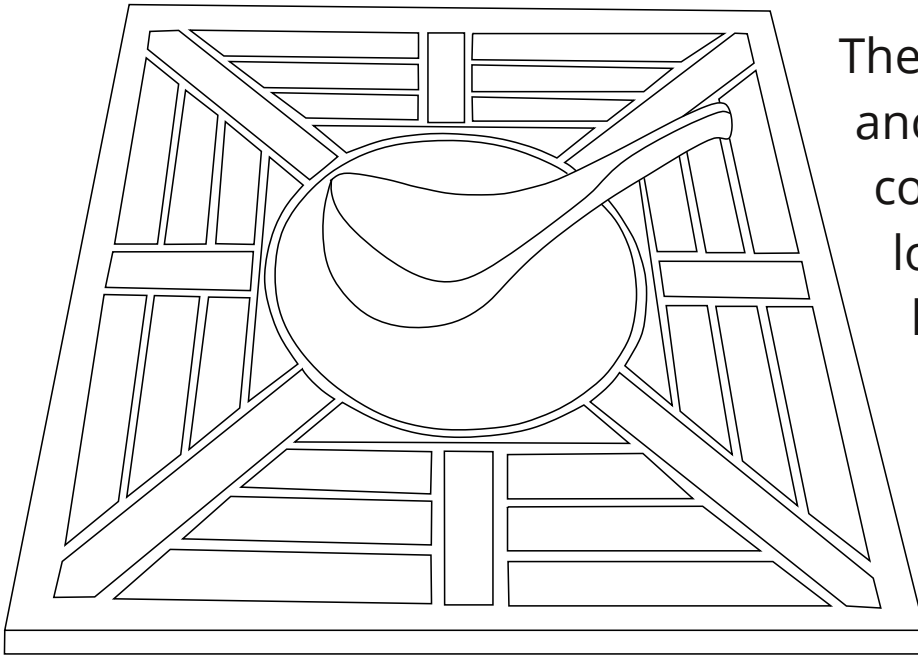

The "spoon" of this ancient Chinese compass is made of lodestone and will line itself up with the Earth's magnetic field, pointing North to South.

A compass is really just a magnet that is free to move around and point in any direction.

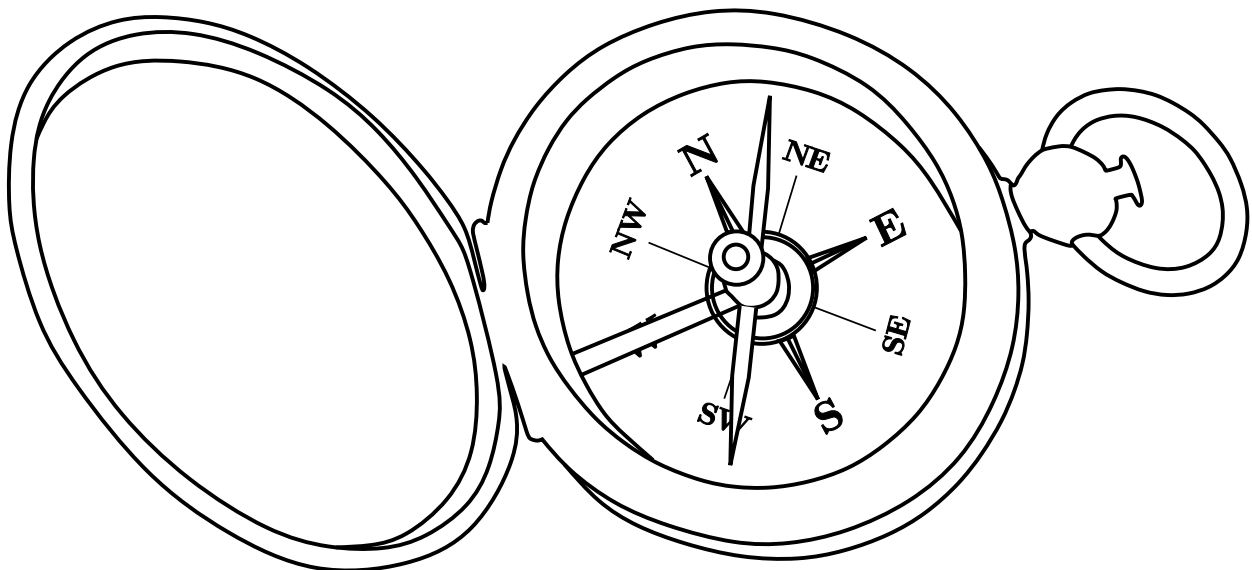

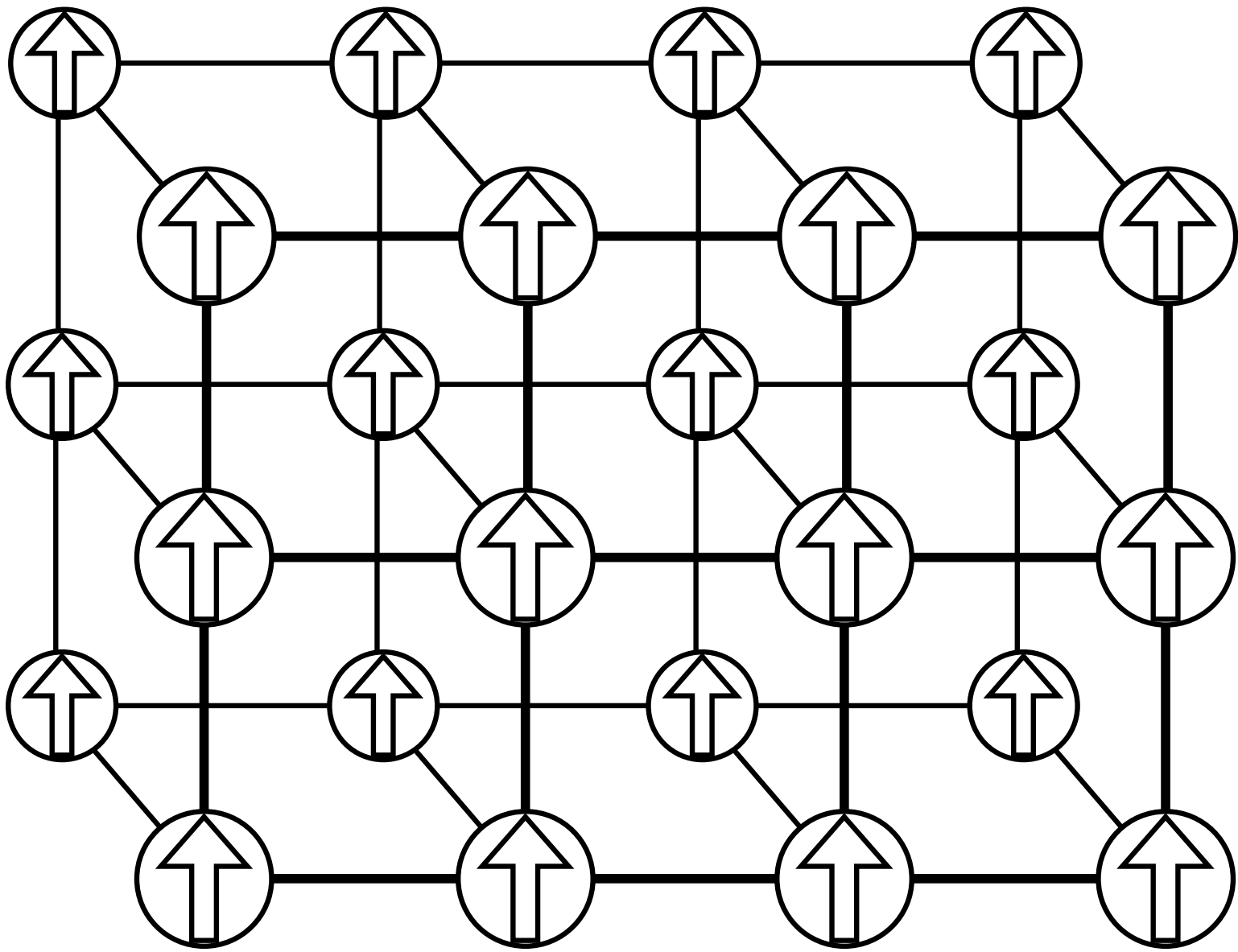

# Ferromagnetism

All of the magnets you usually see and use are called 'ferromagnets'. If you look deep inside a ferromagnet, you see that all of the things that make it up - its atoms - are actually like little tiny magnets themselves, and they all line up in the same direction.

Iron, nickel and cobalt are all ferromagnetic.

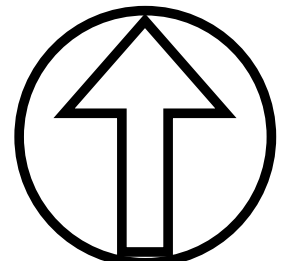
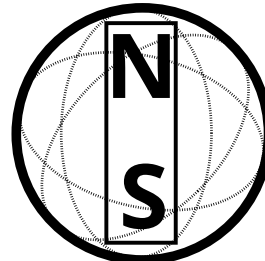
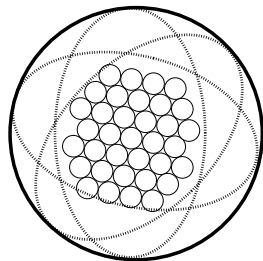
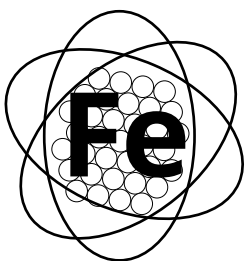

If something is ferromagnetic, it will be pulled towards a magnet. But if the little magnetic atoms line up differently, you can get an 'antiferromagnet' instead.

In this case, each arrow is the other way up to all of its neighbours. This means it won't show any effect if you put a magnet near it.

Chromium is the only antiferromagnetic element at room temperature.

# Antiferromagnetism

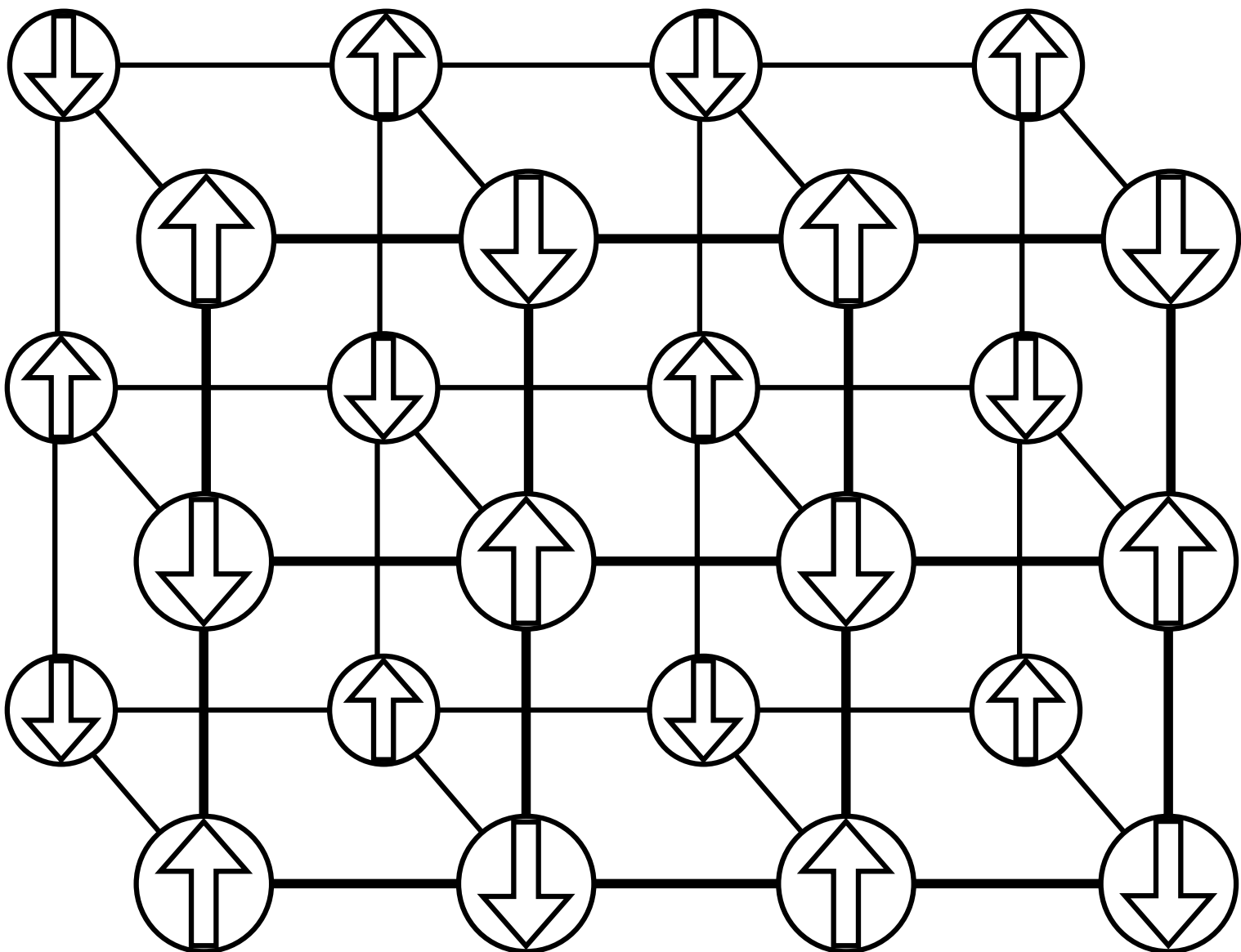

# Paramagnetism

Most of the time in most materials, the atoms don't line up their magnetism. They point all over the place. But if you put a magnet near them, the magnet can make all of the atoms line up.

In some materials, the atoms line up so that they are pulled towards the magnet. Materials that do this are known as 'paramagnetic'.

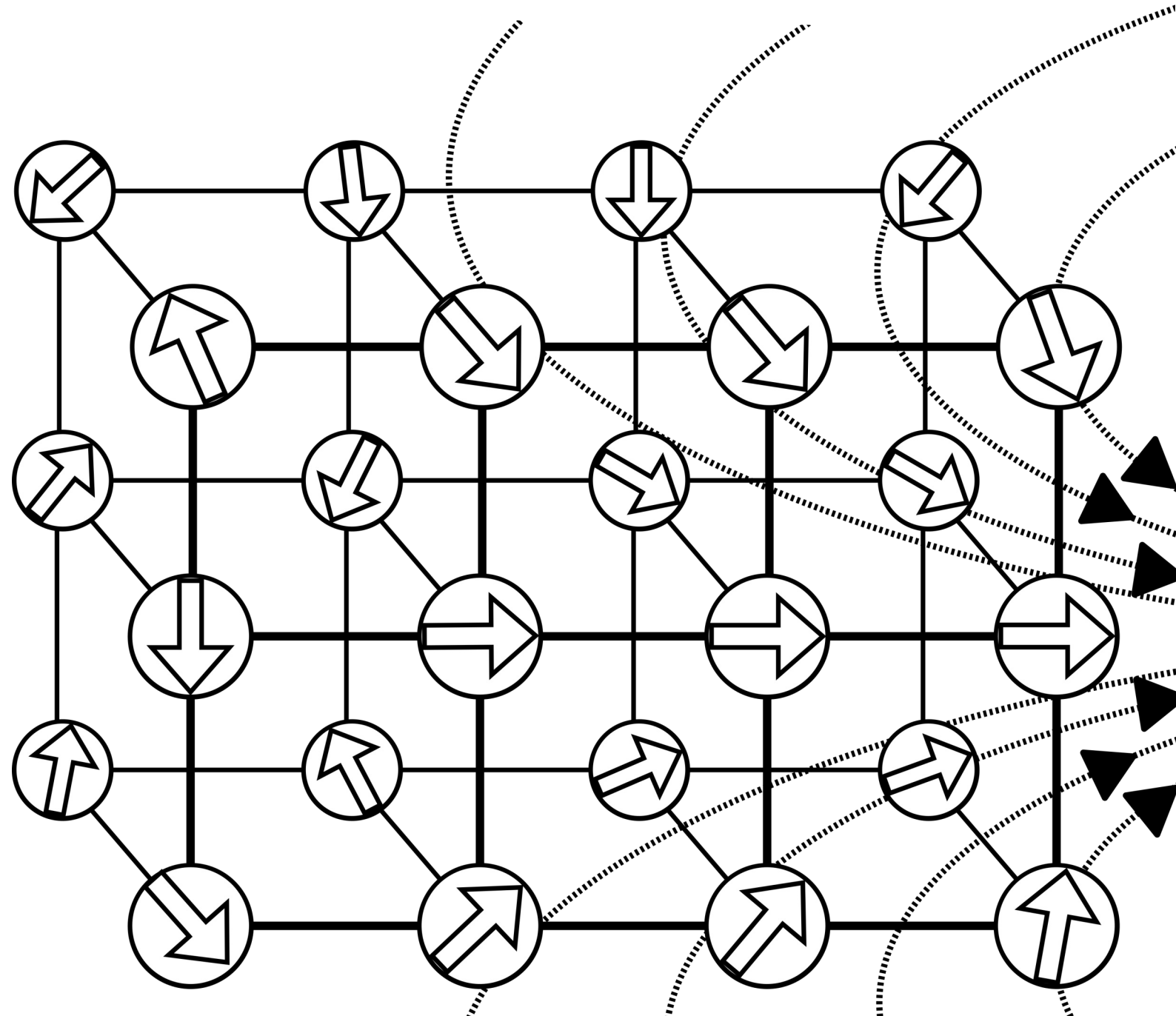



Copper sulfate crystals are a bright blue colour, and you can grow them yourself.

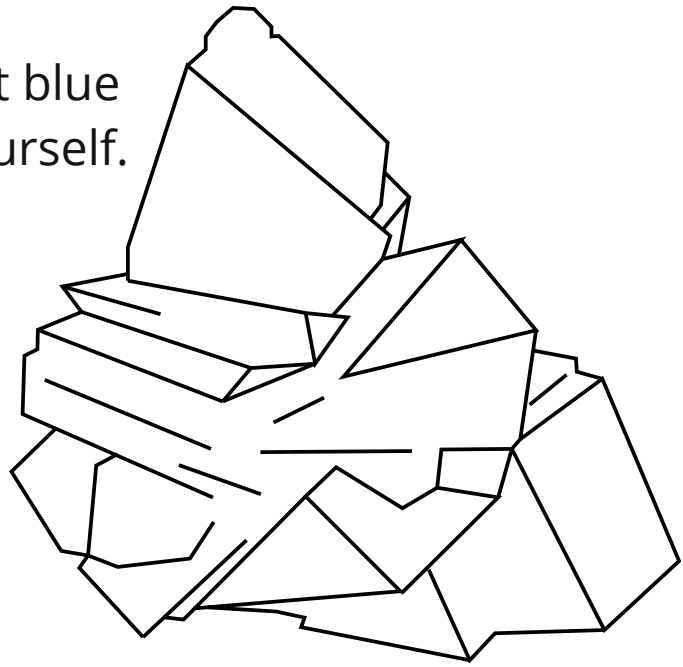

Copper sulfate is paramagnetic, so if you put a strong magnet near it, it will be attracted to the magnet.

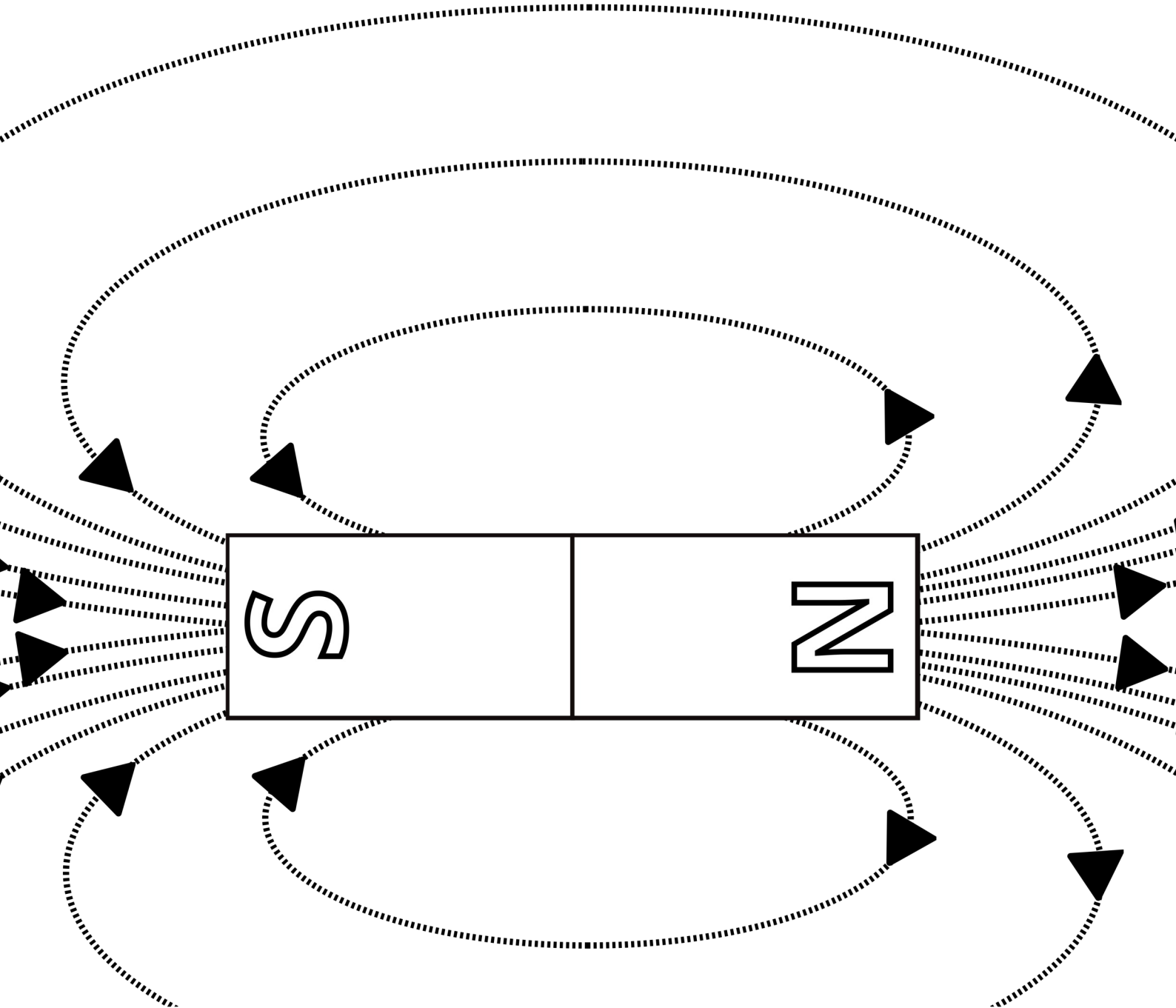

# Frustrated magnetism

Imagine two magnets that can't move anywhere but are free to spin around.

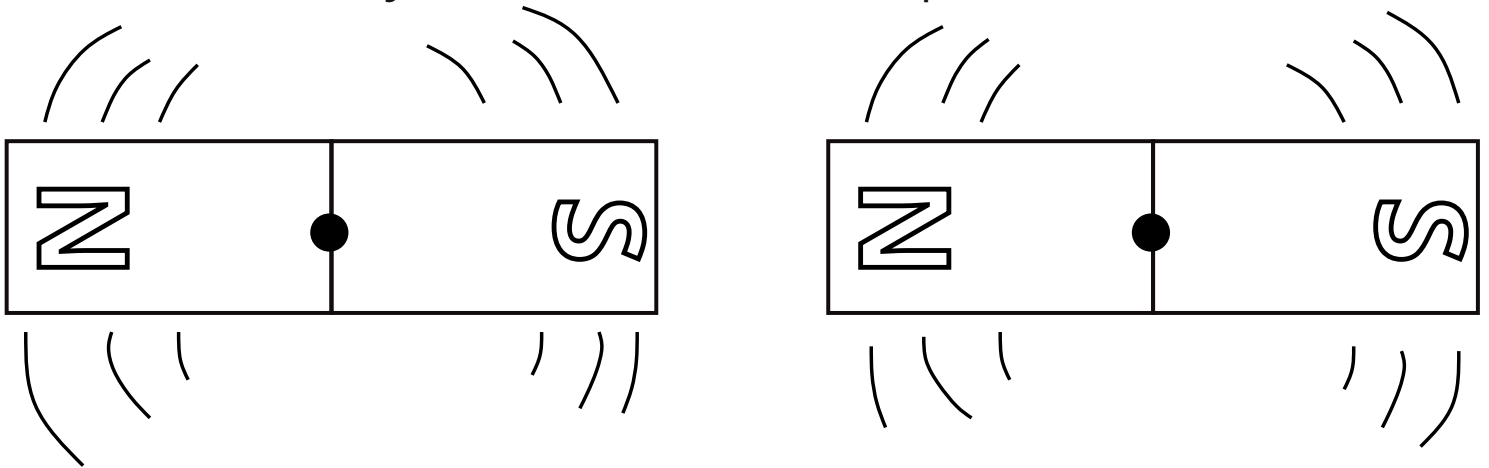

They will spin so that the North pole of one and the South pole of the other are pointing directly at each other.

But what if we add a third magnet? Which way will it point?  
The North pole is attracted to the nearby South pole, but the South pole is attracted to the nearby North pole!

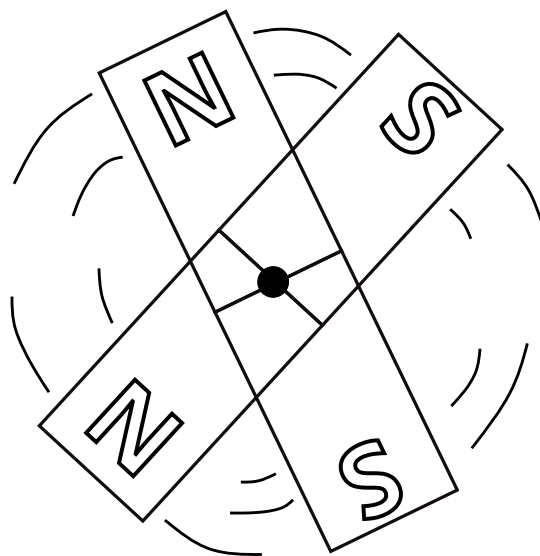
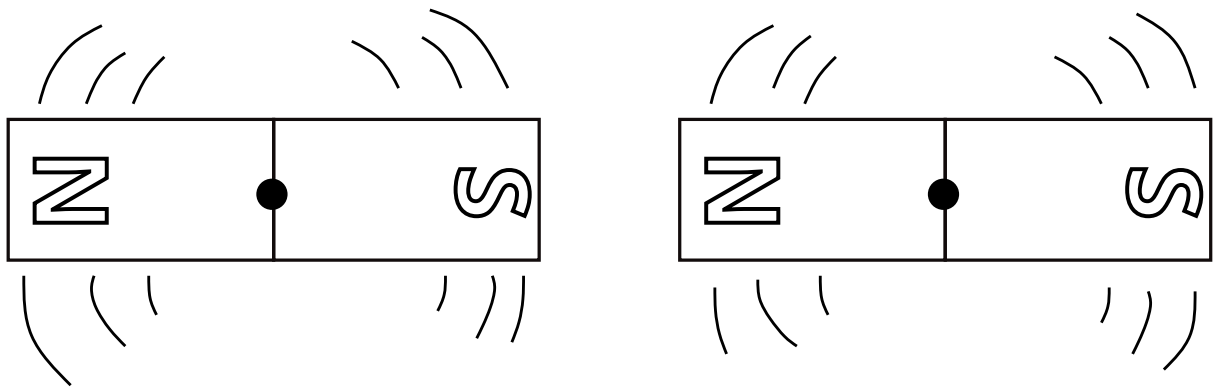

In fact, the magnets will find a compromise, where they all share the attraction and repulsion. Because there isn't a way to make all the north poles be near only South poles, and the south poles be near only North poles, the magnets end up in this strange arrangement.

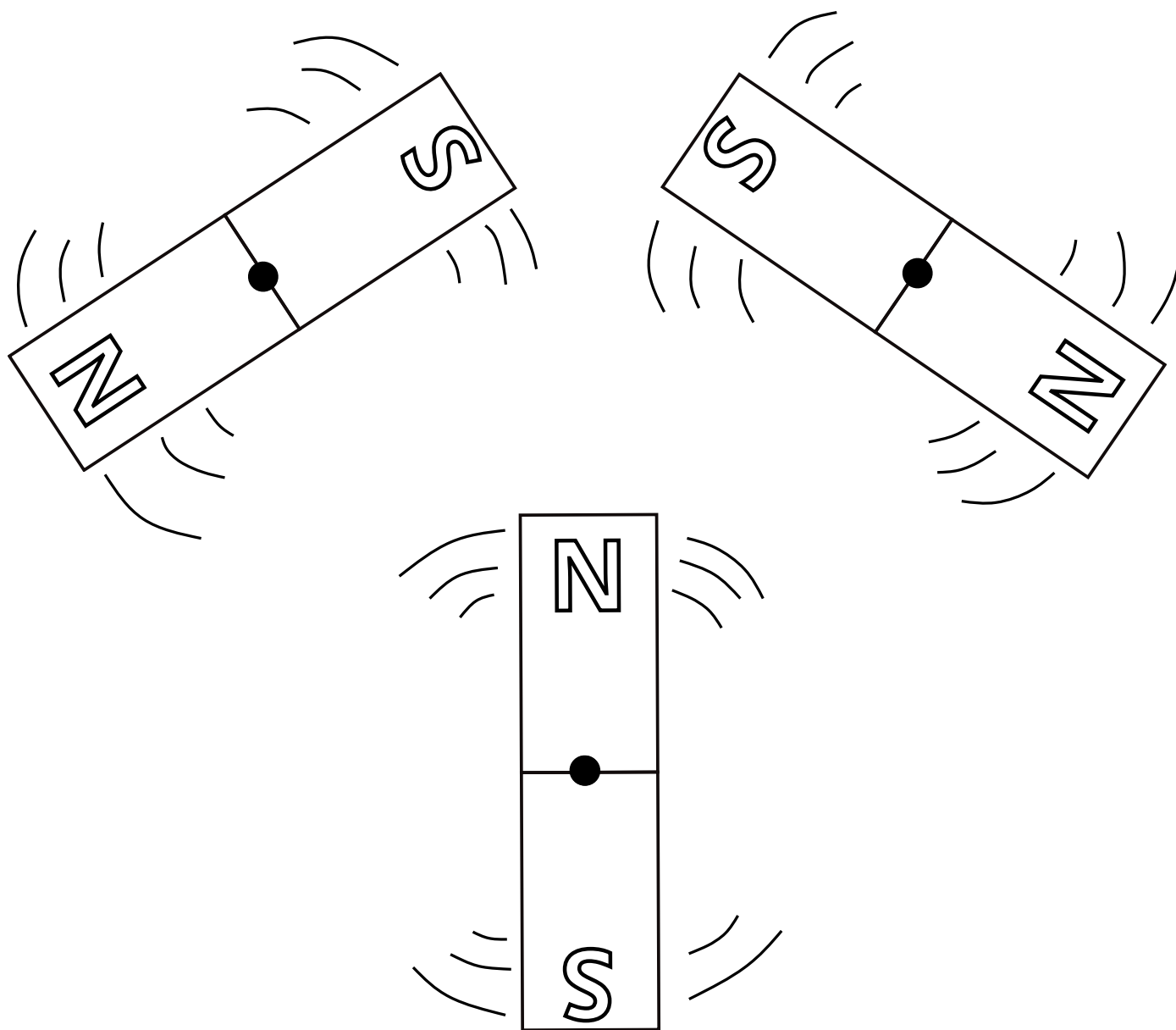

This is known as 'frustrated magnetism'.

You can do this with bar magnets, but the same can happen within magnetic materials - the tiny magnetic atoms can't find an orientation that makes them all happy, so they go with one that makes them all equally unhappy!

# Vortices & Skyrmions

The 'spin' of an atom is the magnetism that atom has. We usually use an arrow to represent it.

The spins of atoms often line up in interesting ways. In certain materials they can be made to point round and round in a vortex - like the wind in a tornado or the water in a whirlpool.

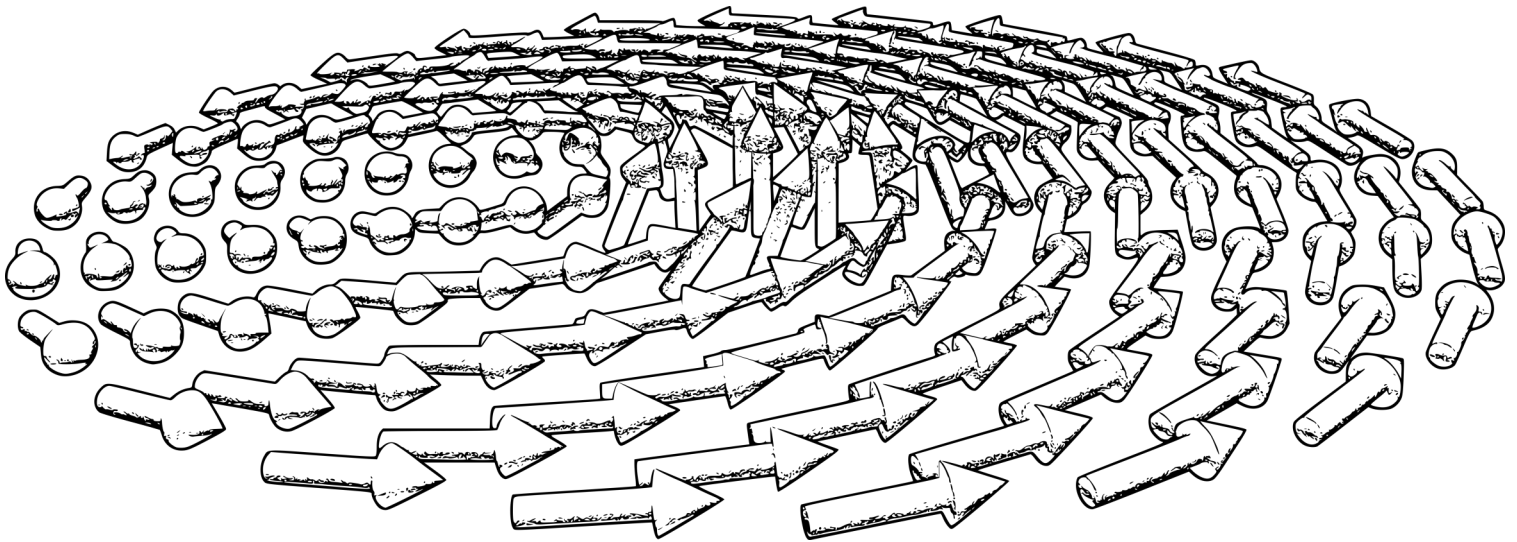

Spins can also create patterns called 'skyrmions', where spins at the edge point up and spins in the centre point down. A vortex skyrmion has the spins in between pointing around in a circle, but a 'hedgehog skyrmion' has the spins like this:

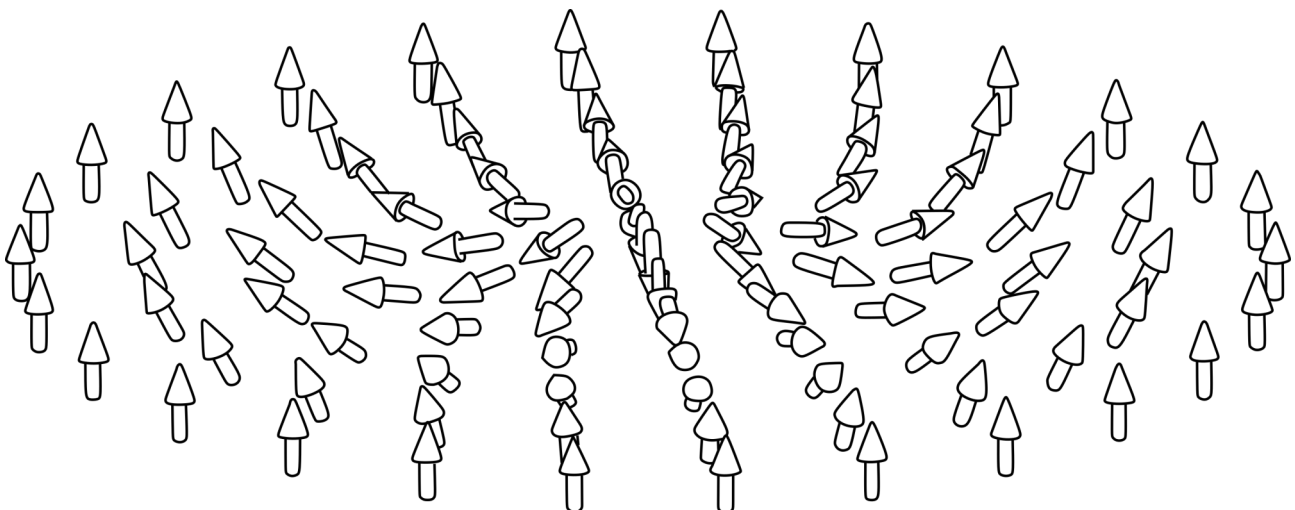

# Spin waves

Spins can interact with their neighbours, so chains of spins can move together, with each spin nudging its neighbour. By moving one spin, you can make a 'spin wave' travel along the chain, like a pulse travelling along the length of a spring.

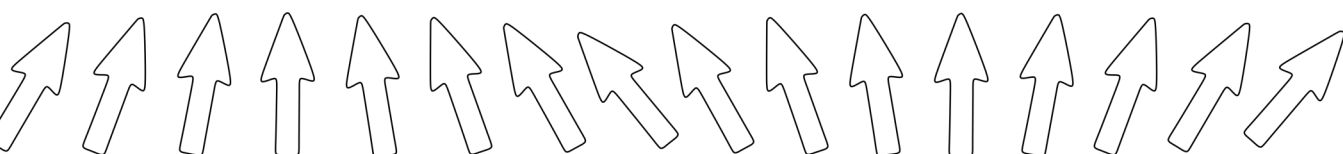
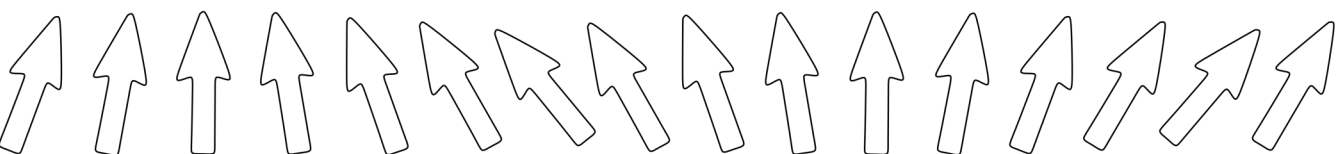
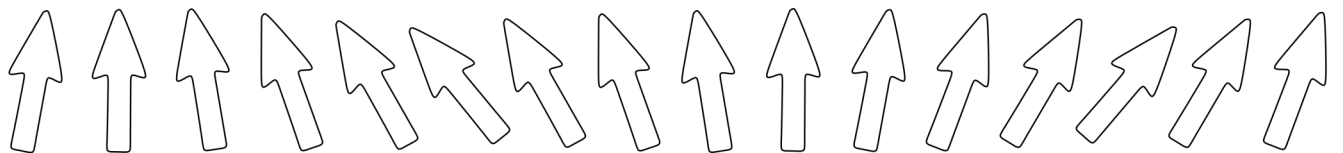
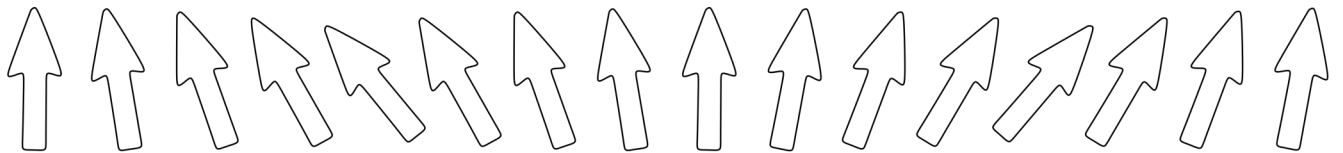

# Superconductivity

Superconductors are amazing materials that let electricity pass through them with no resistance. This means you can get out all the energy you put in!

Superconductors behave very strangely when you put them near magnets. Here, the superconductor is a round disk, and underneath it are powerful bar magnets.

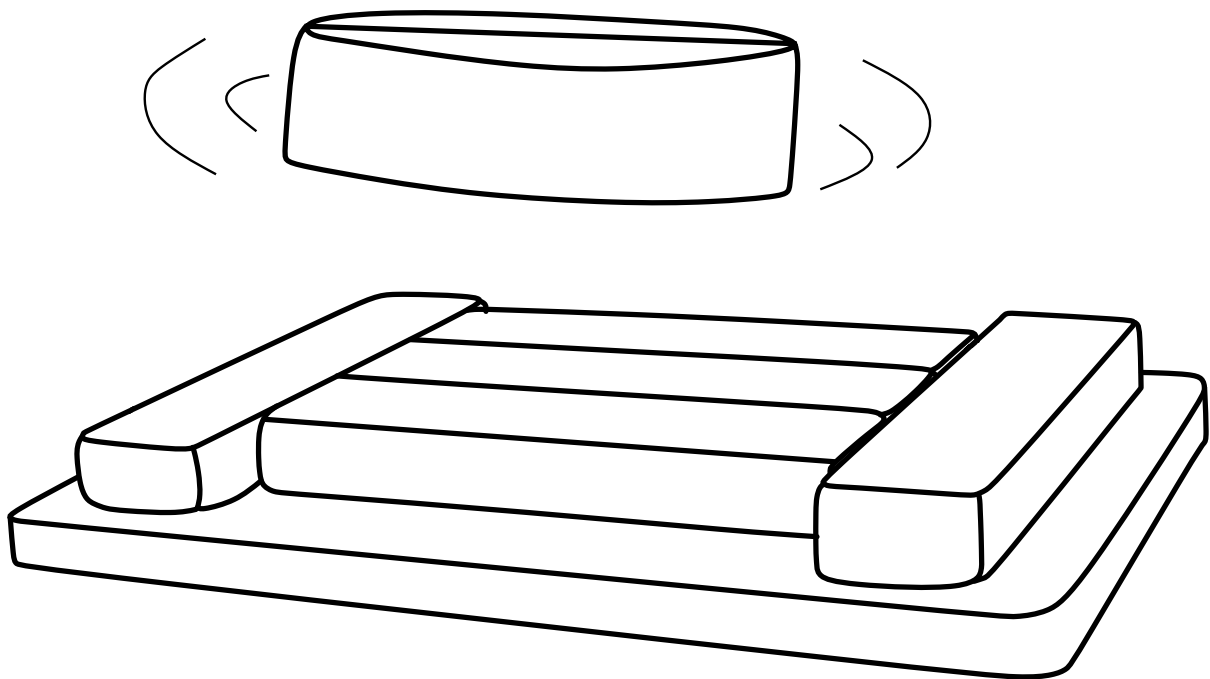

The superconductor will float above the magnets!

# The Meissner Effect

Superconductors don't like to be near magnets, because they don't like to have magnetic fields going through them.

To keep the external magnetic field out, they make a magnetic field of their own, and they make it exactly the same as the one they are near.

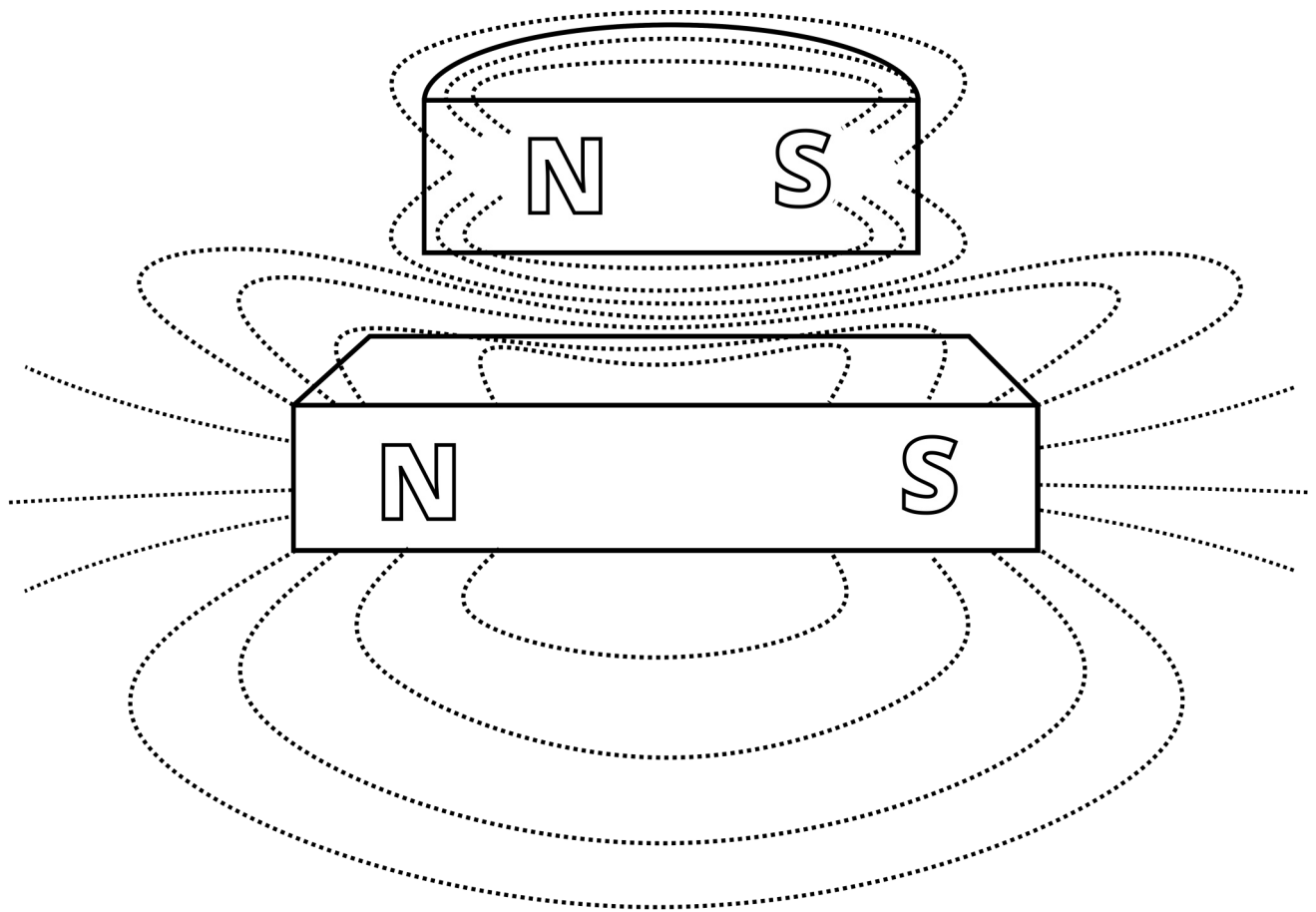

Two North poles repel, and two South poles repel, so the superconductor pushes itself away from the magnet - the superconductor and the magnet repel one another.

This is what lets superconductors float in mid-air above magnets. It's called the 'Meissner Effect'.

# Cooling

In order to work, superconductors  
have to be very, very cold.

Many of them have to be colder than  $-200^{\circ}\text{C}$ !

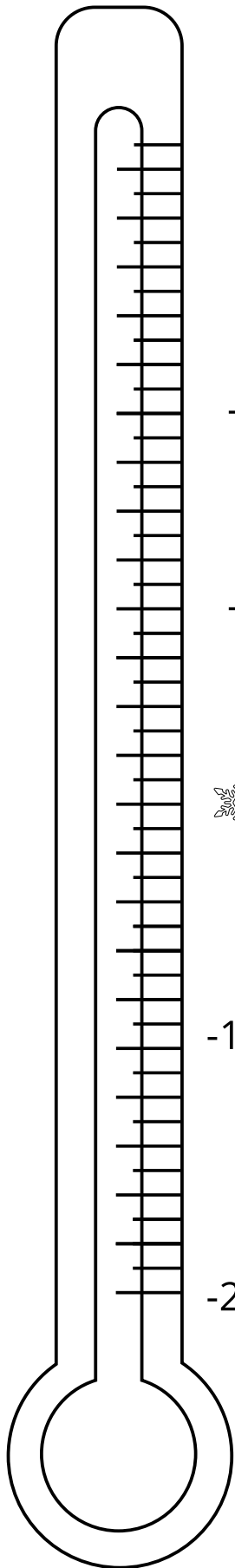

$37^{\circ}\text{C}$  - body temperature

$21^{\circ}\text{C}$  - room temperature

$0^{\circ}\text{C}$  - freezing point of water

$-18^{\circ}\text{C}$  - inside a freezer

$-89^{\circ}\text{C}$  - coldest temperature recorded outside on Earth

$-180^{\circ}\text{C}$  - Yttrium barium copper oxide superconducts

$-273^{\circ}\text{C}$  - the coldest possible temperature

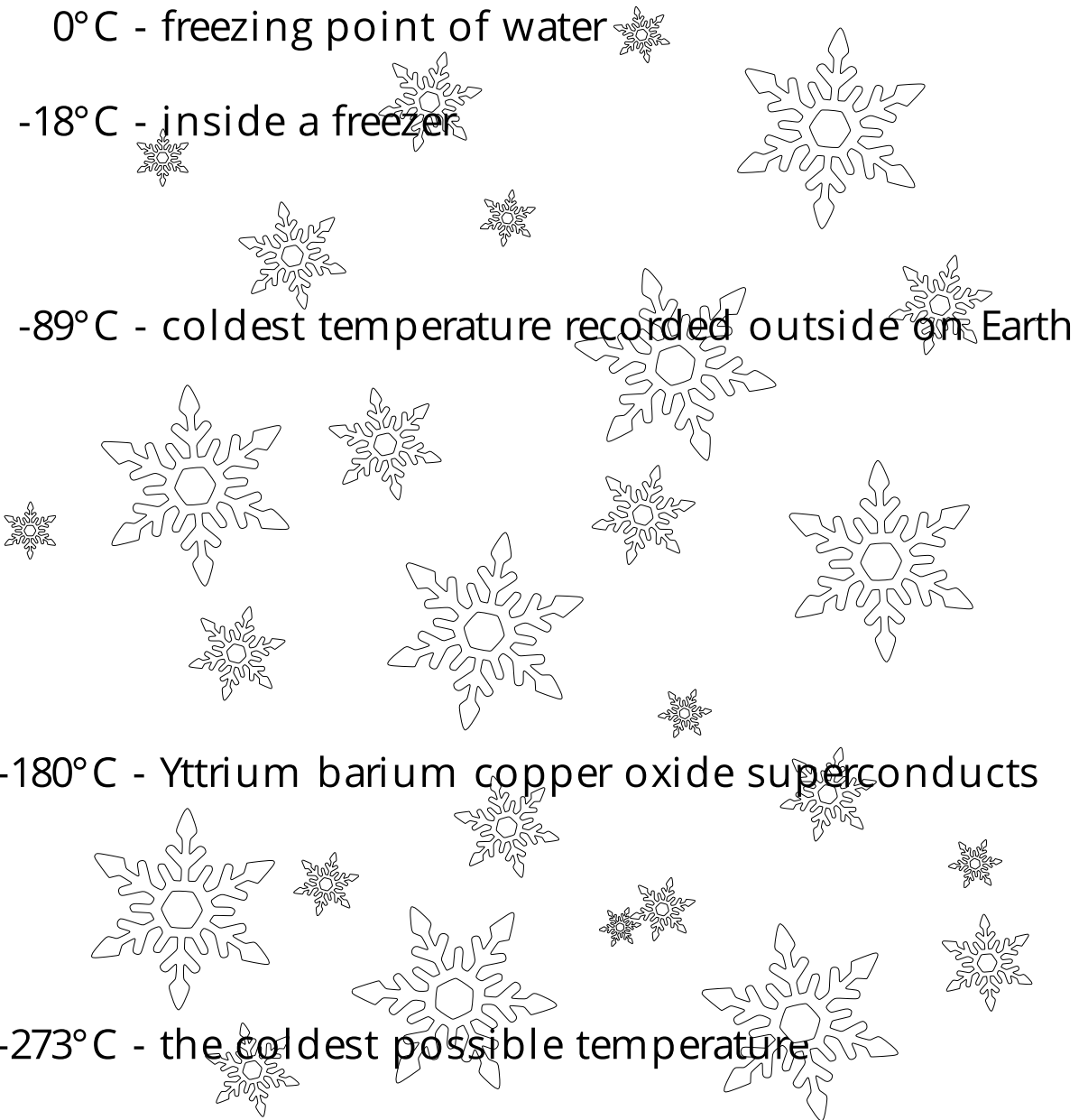



# Flux pinning

If you cool the superconductor down while it is in a magnetic field, the magnetic field gets "locked" into the superconductor - this is known as 'flux pinning'. The field will find little imperfections and defects in the superconductor and go through those, and little electric currents will circle around these imperfections.

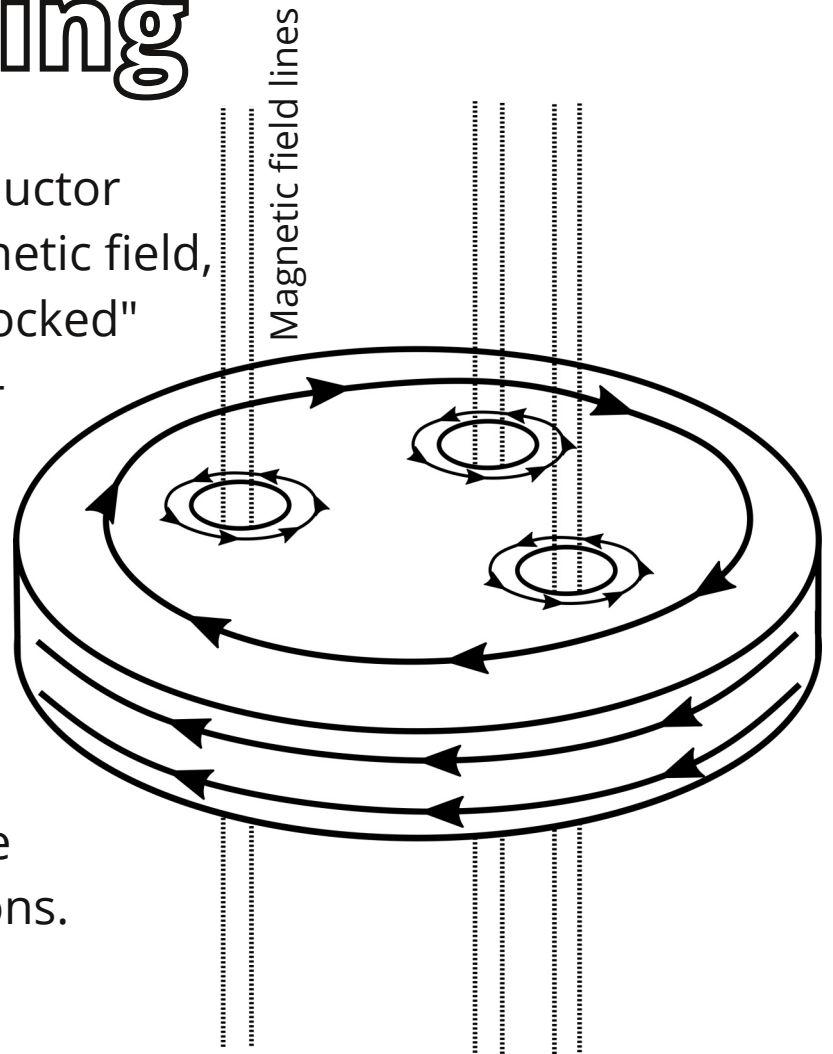

When a superconductor has the magnetic field pinned in it, it doesn't want to change that magnetic field at all. This means that the superconductor wants to stay exactly where it is, so it will float above the magnet, or it will hang underneath the magnet, always at exactly the distance it was at when it was cooled down.

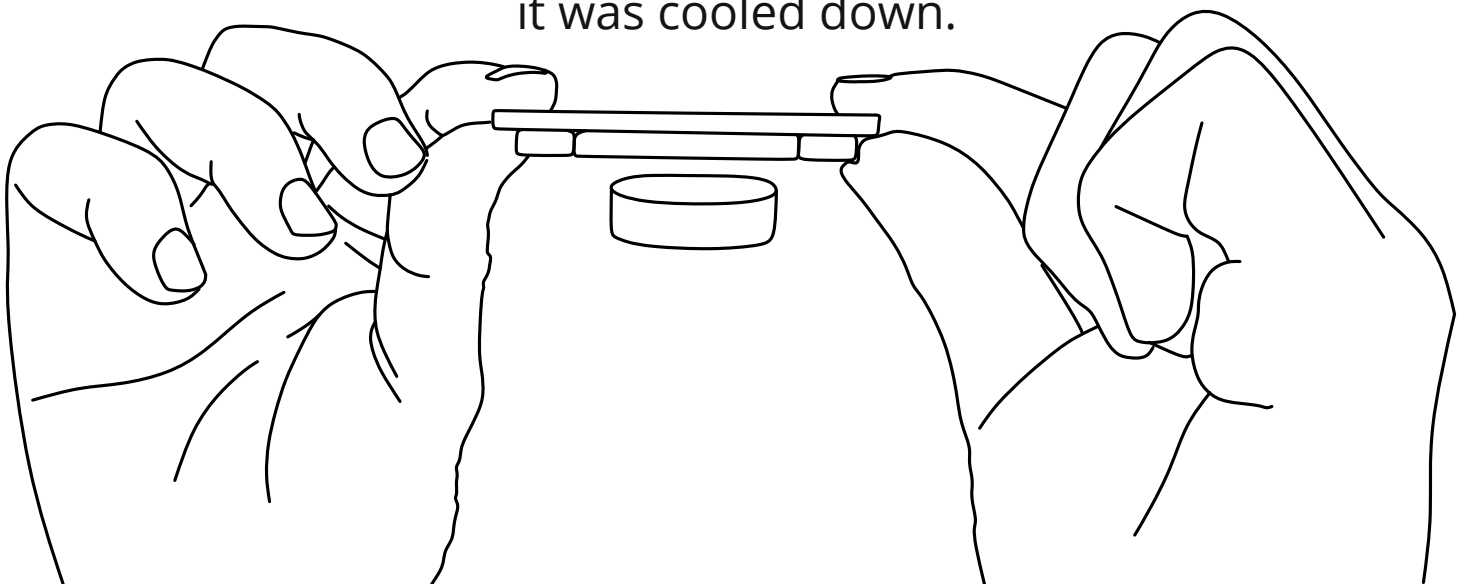

# Superconducting Wires

Some superconductors can be shaped like wires. A superconducting wire can carry much more electricity than a normal wire because it has no electrical resistance.



COPPER  
CABLE

This superconducting cable can carry as much electricity as all the normal cables put together!



SUPERCONDUCTING  
CABLE

If you take a wire and coil it around and around, and then put an electric current through it, you can make a magnet! This is called an 'electromagnet'. If you do this with superconducting wires, you can make a super-strong electromagnet.

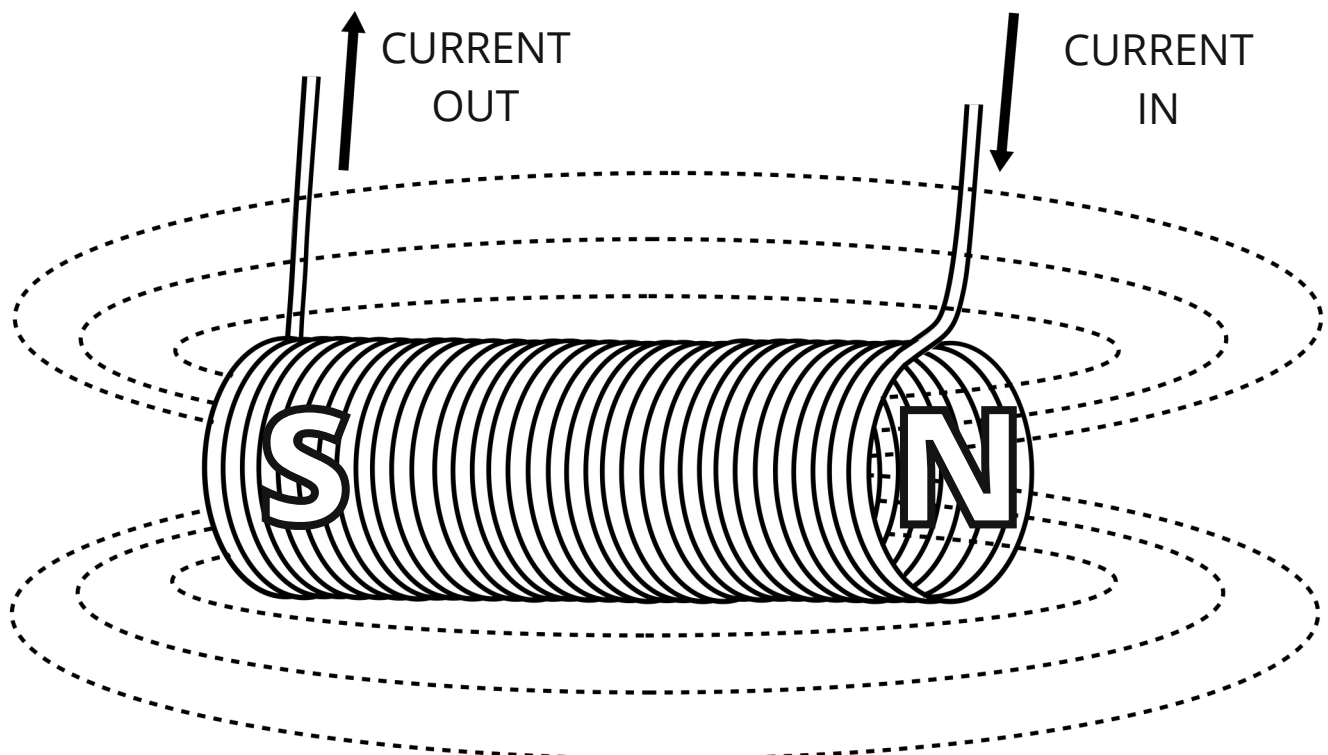

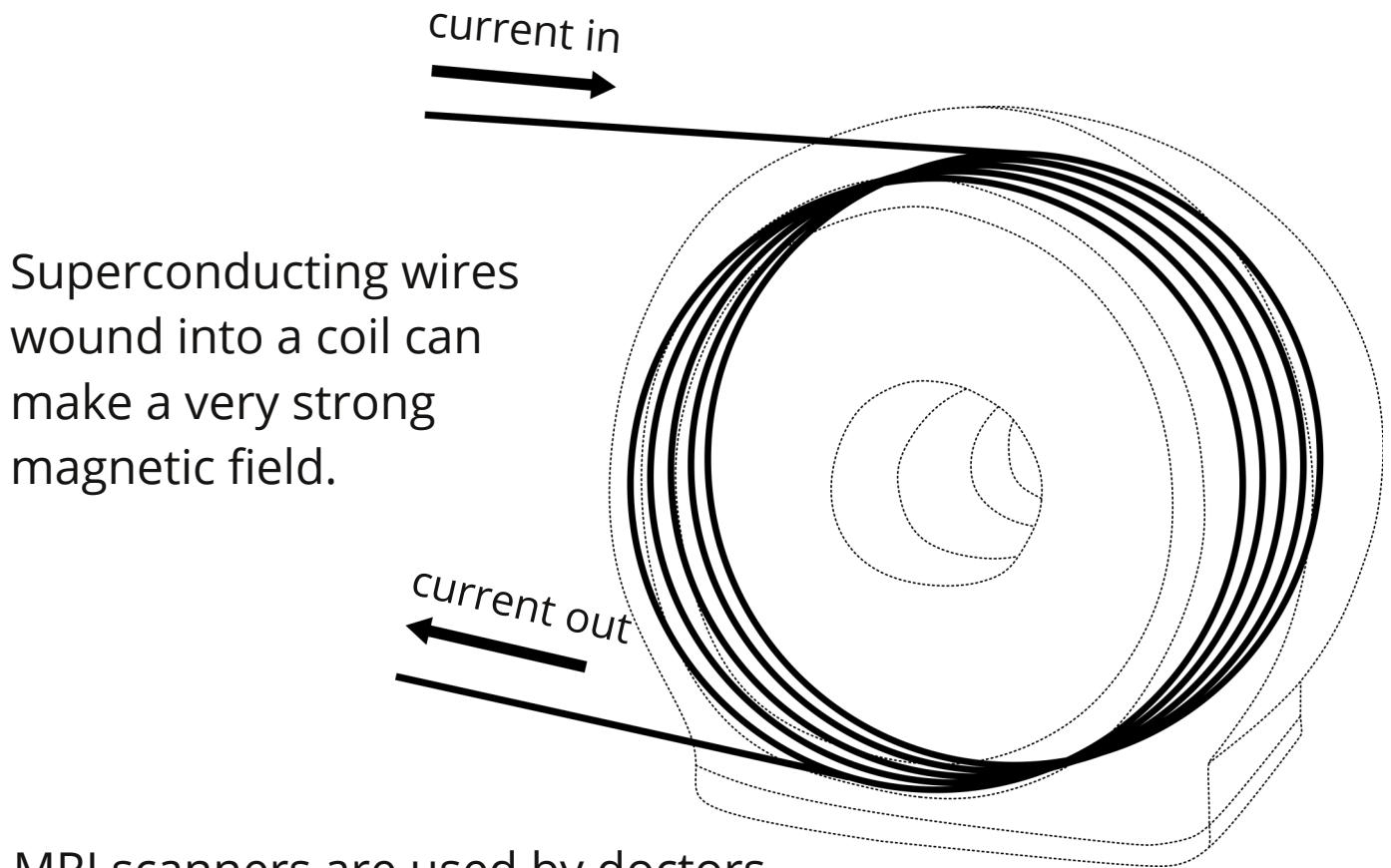

MRI scanners are used by doctors to see inside your body with very strong magnetic fields. Inside an MRI scanner is a giant coil of superconducting wire and when an electric current passes through the wire, it creates an enormous magnetic field.

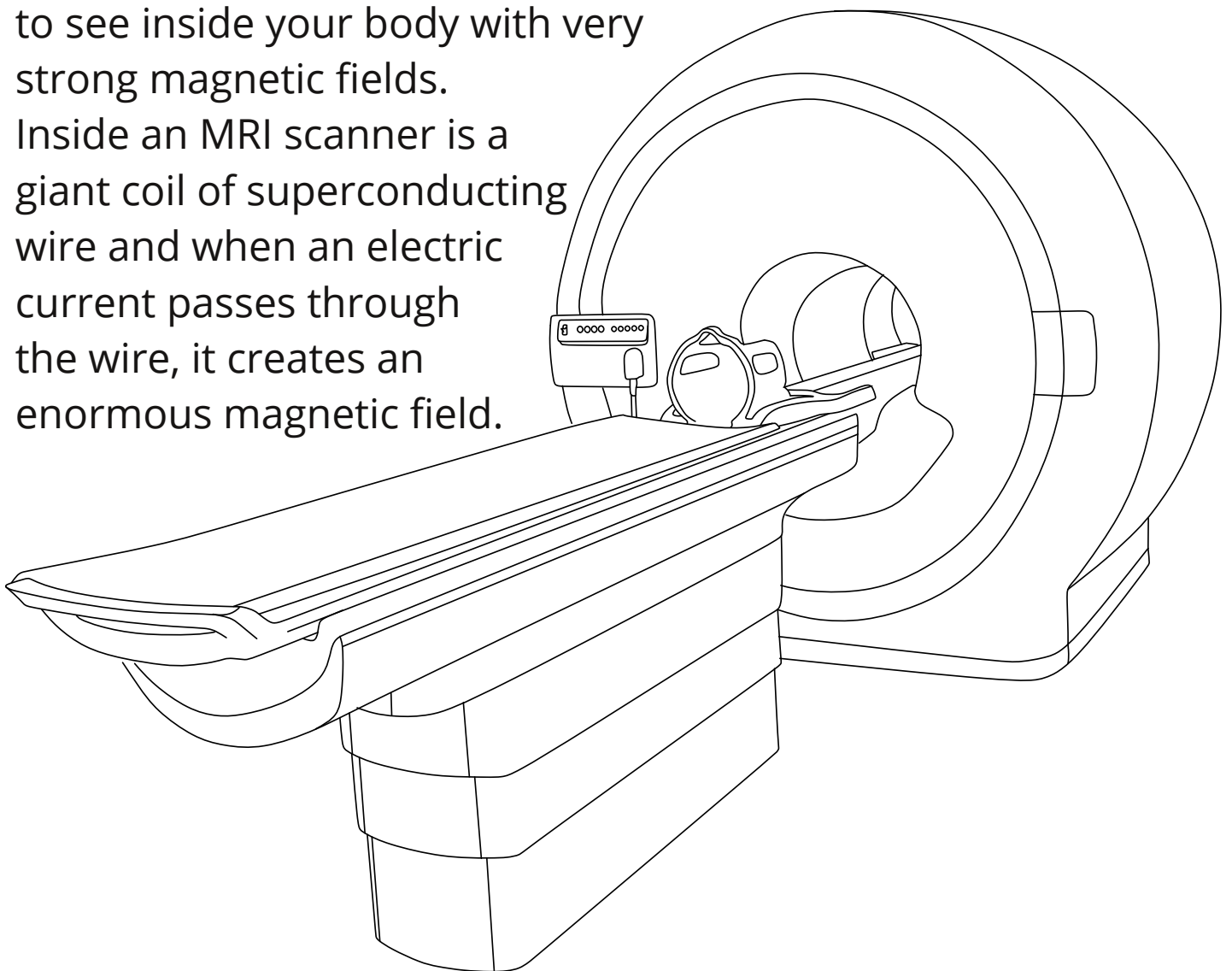

# Doing experiments

Some experiments studying quantum materials such as superconductors can be done in laboratories in the university.

These experiments often involve getting the material very cold, as this can make it easier to see what is going on. The data that comes out will be recorded on a computer, and a scientist will study the data to see what they can find out.

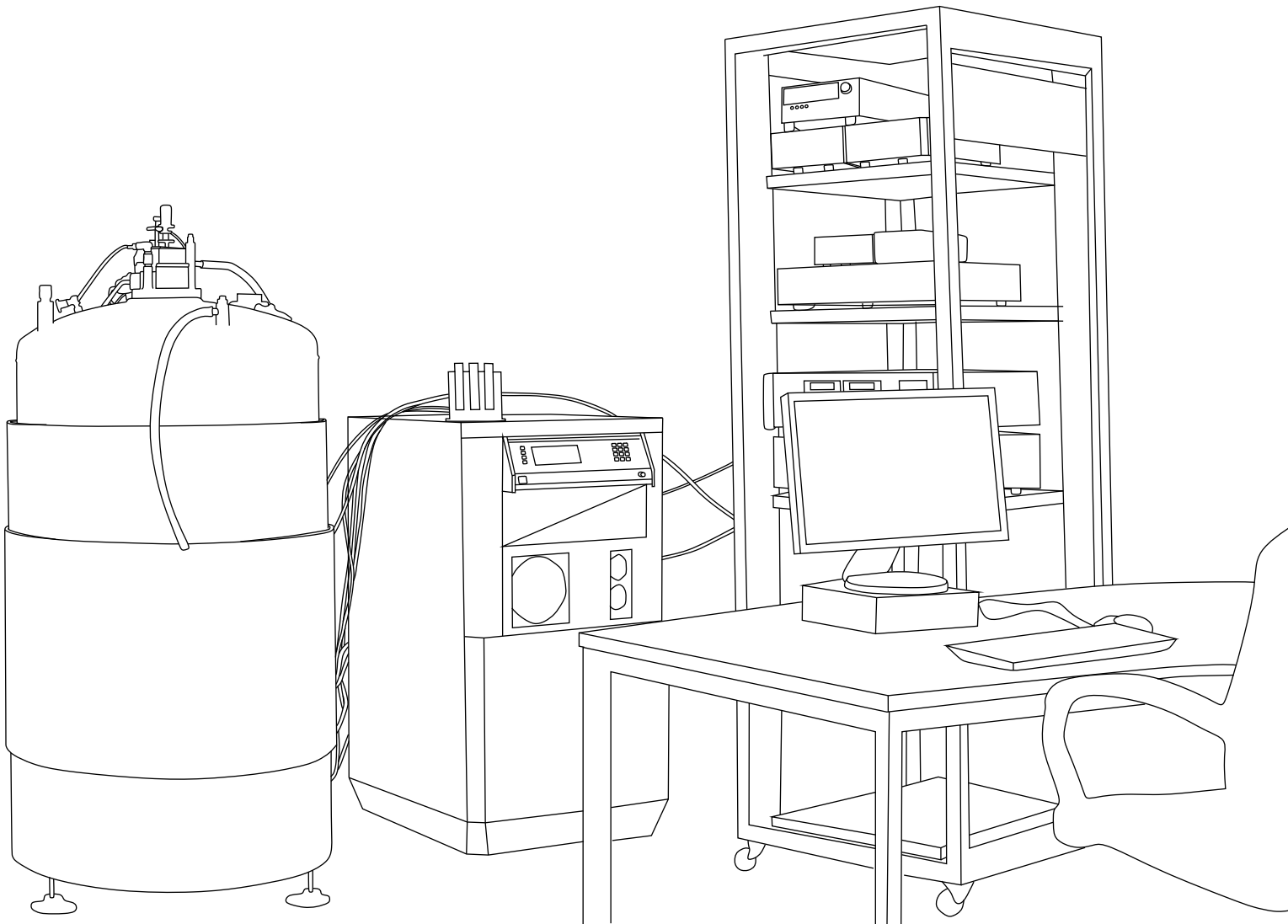

Sometimes the equipment in a university laboratory is not powerful enough for you to see the complicated and tiny physics the scientists are trying to understand. When that happens, they need to find a bigger lab!

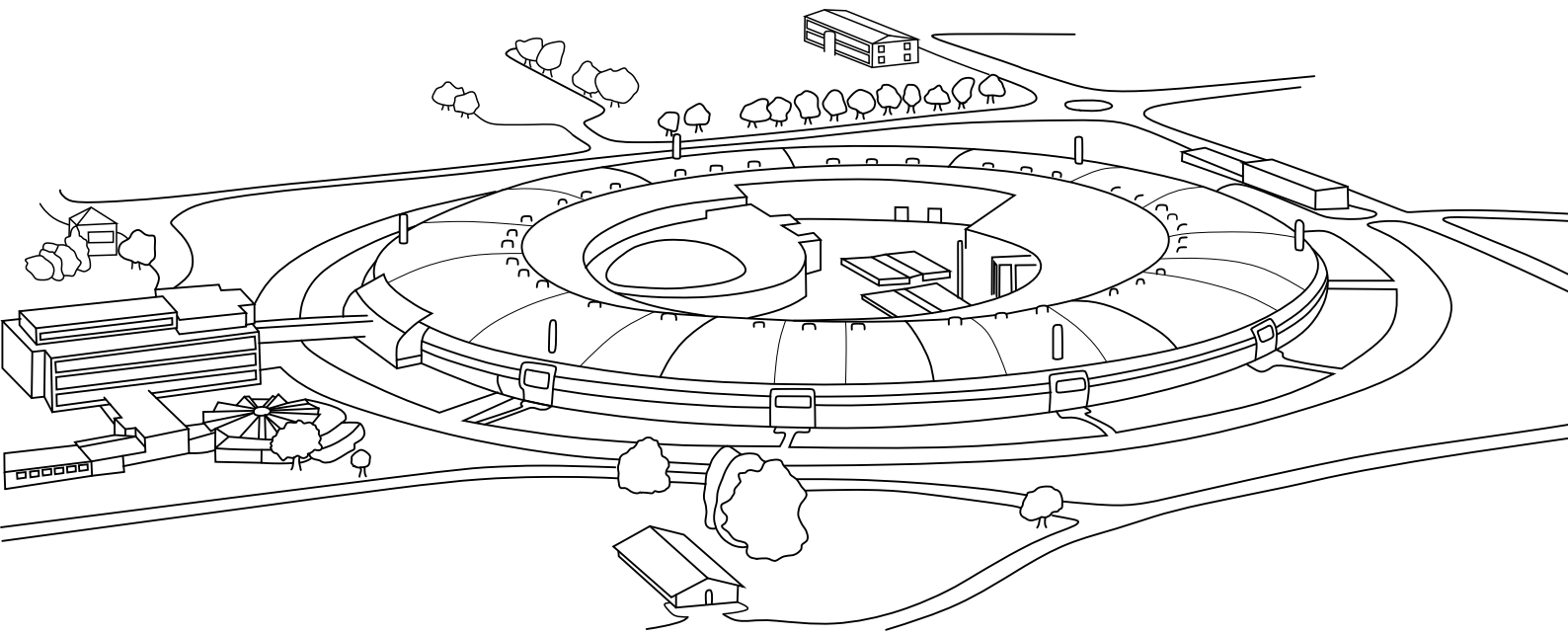

For example, Diamond Light Source is a huge scientific research facility near Oxford that produces X-rays to shine on all kinds of materials. These X-rays are 10 billion times brighter than the sun!

We can use the X-rays to study quantum materials and understand their properties.

# Find out more

There are lots of ways you can find out more about quantum materials and the work we do.

Our research website:

[www2.physics.ox.ac.uk/research/quantum-materials](http://www2.physics.ox.ac.uk/research/quantum-materials)

Our outreach website:

[www.physics.ox.ac.uk/qmoutreach](http://www.physics.ox.ac.uk/qmoutreach)

You can find loads of great videos on our YouTube channel:

<http://bit.ly/QMOYouTube>

Twitter: @QM\_Oxford

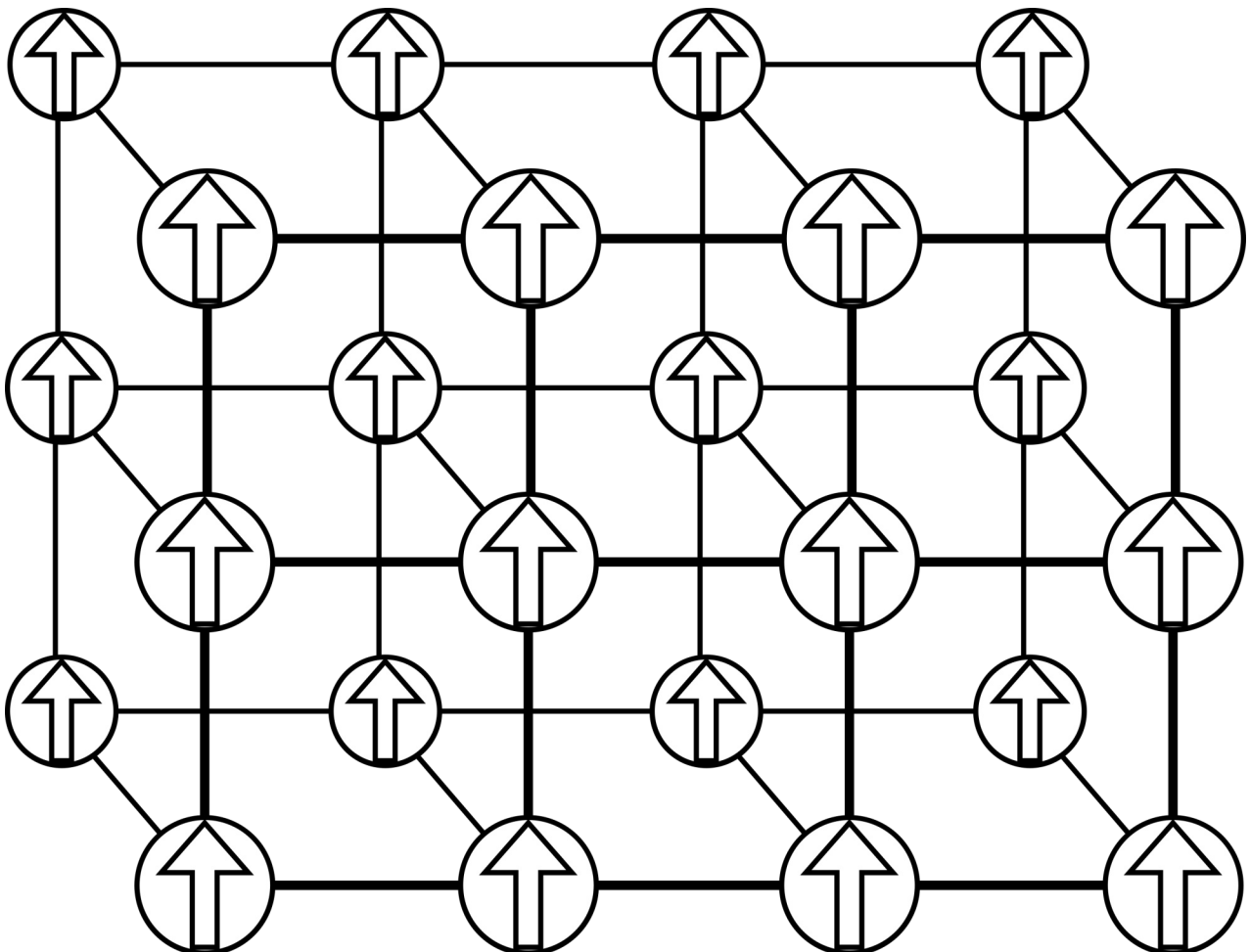

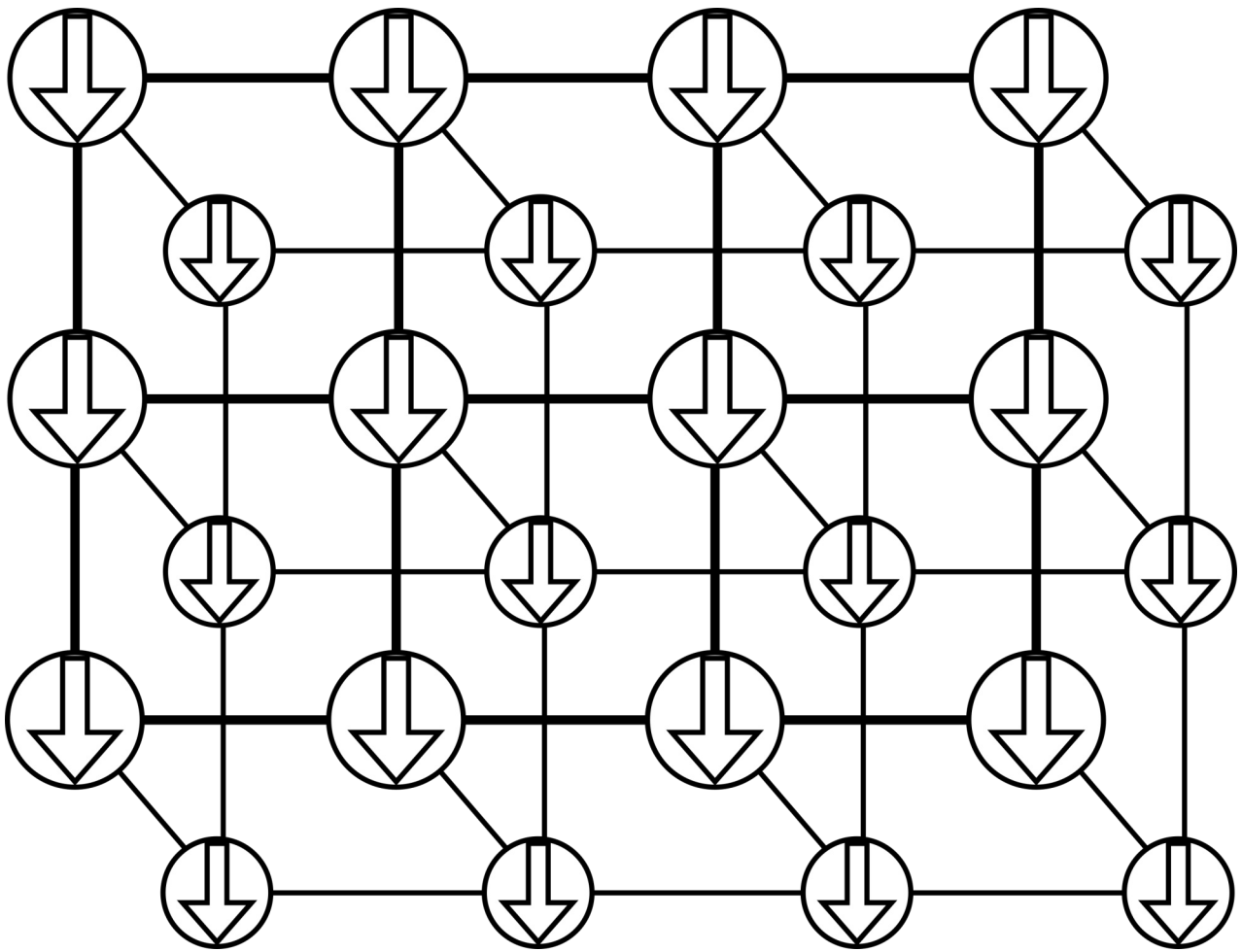

# Credits

Original images by:

Prof Andrew Boothroyd

Prof Stephen Blundell

Jan Ainali (Wikimedia)

Francis Chmiel

Karin Everschor-Sitte and Matthias Sitte

Dr Kathryn Boast

Diamond Light Source

Line drawings by Dr Kathryn Boast

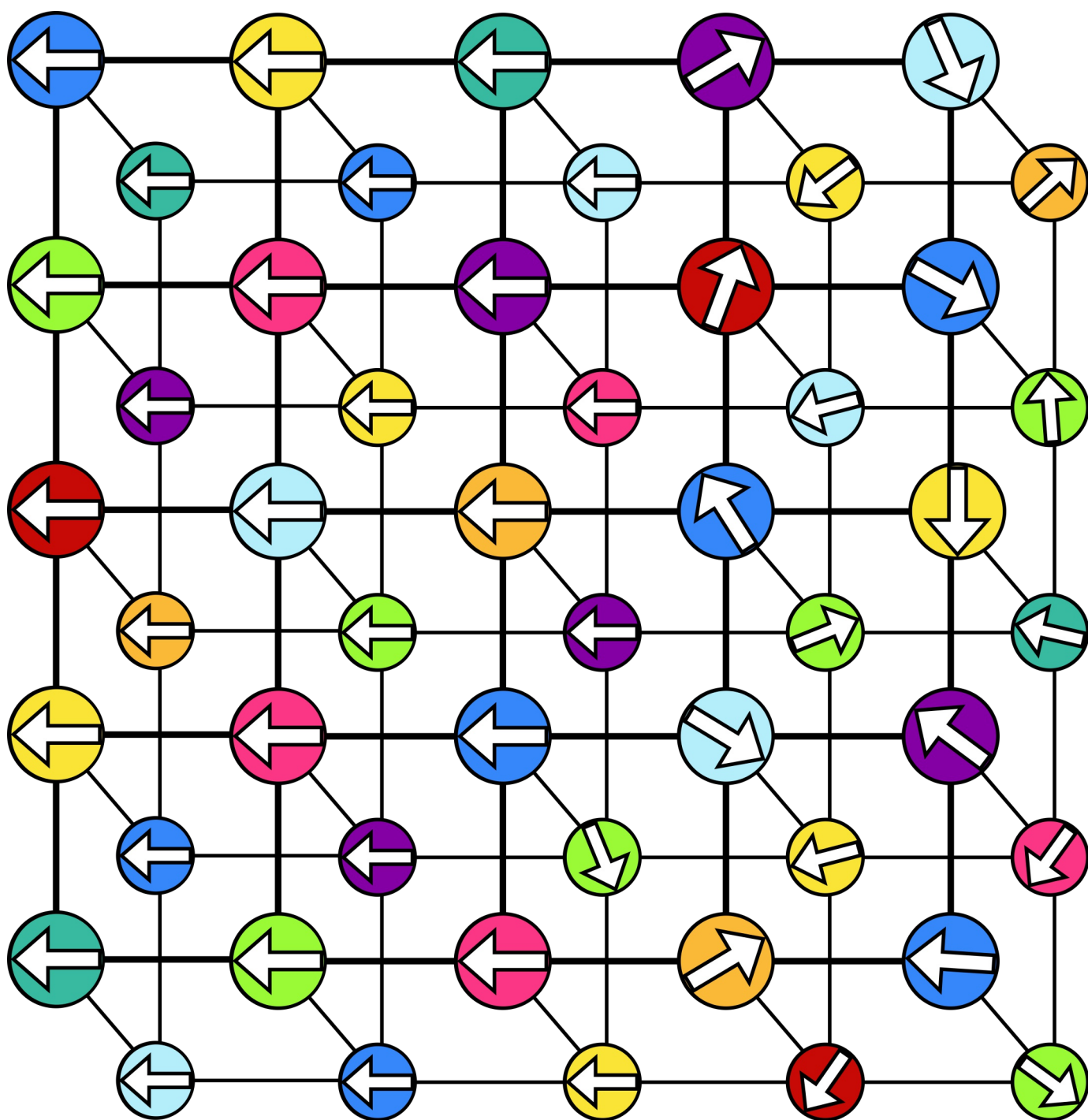

The Quantum Materials Colouring Book has been designed by Dr Kathryn Boast for the Quantum Materials Group in the Department of Physics at the University of Oxford.